



Unlocking synergies: Comprehensive analysis and challenges in the integration of reverse osmosis with reverse electrodialysis.

Authors: Stefany Fernandez Rojano, Ing. Ricardo Mejia Marchena, PhD, and Aymer Maturana Cordoba, PhD.



Instituto de Estudios Hidráulicos y Ambientales (IDEHA), Departamento de Ingeniería Civil y Ambiental, Uninorte.

TABLE OF CONTENTS

01

Introduction

Brief description – Case study.

02

Pretreatment

Conventional

03

Desalination

Reverse Osmosis

04

Salinity Gradient Energy

Reverse electrodyalisis

05

Conclusions

Future works.

01

INTRODUCTION

Salinity Gradient



Bocas de ceniza – Caribbean Sea and Magdalena River



Barranquilla, Atlántico, Colombia

- Salinity gradient energy has a huge potential as alternative and sustainable energy source.
- Pressure-retarded osmosis (PRO) and reverse electrodialysis (RED) are the most frequently studied processes to extract the potential energy available from the mixing of freshwater and saltwater.

02

PRETREATMENT

CONVENTIONAL PRETREATMENT



Initial conditions:

- River water: 260-605 NTU, SDI >20, 9-11 mg/L de TOC.
- Seawater: 12.5-103 NTU, SDI >20, 20-30 mg/L de TOC.

CONVENTIONAL PRETREATMENT

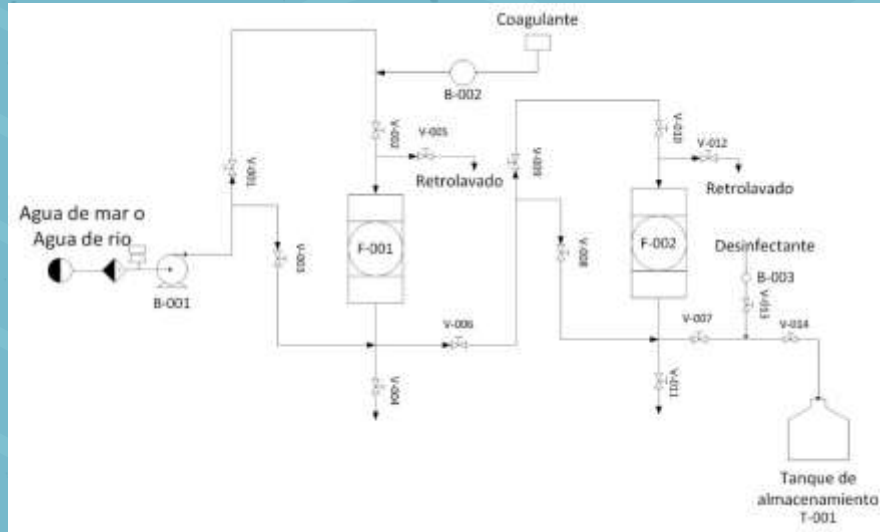

- Design of Experiment (DoE): Categorical Multilevel Factorial.
- Assessment of various filter's bed compositions.
- Coagulation with Polyaluminium chloride hydroxide sulfate.
- Pressure: 10-35 PSI

CONVENTIONAL PRETREATMENT

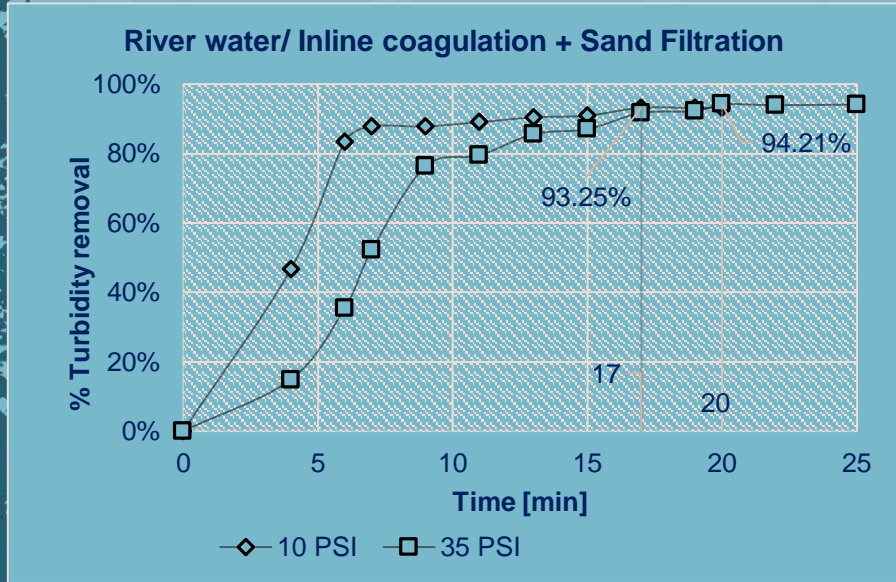

After selected conventional pretreatment (River water): 1.33 NTU, 3.6 mg/L TOC y SDI 3.6 – 4.9.

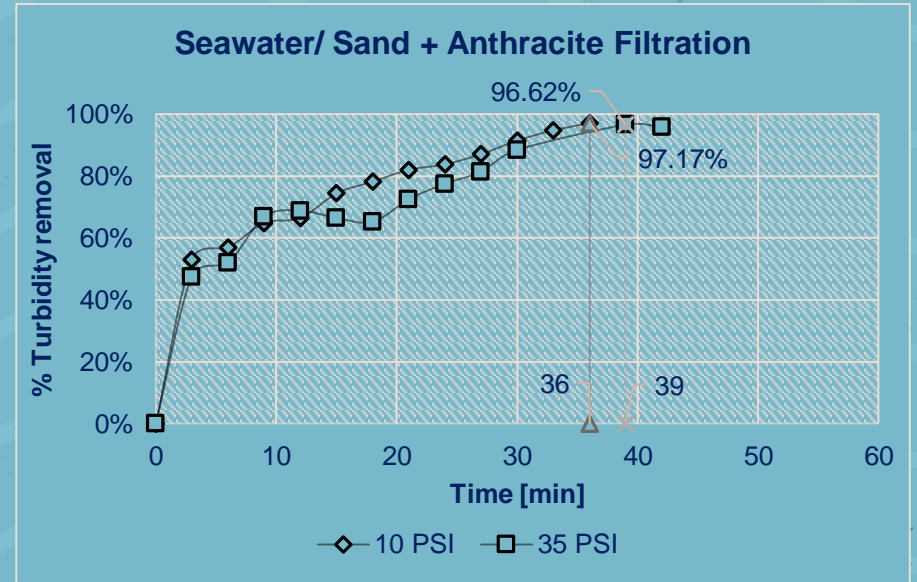

After selected conventional pretreatment (Seawater): 0.89 NTU, 2-3 mg/L TOC y SDI 3.3 – 3.5.

03

DESALINATION

DESALINATION BY REVERSE OSMOSIS

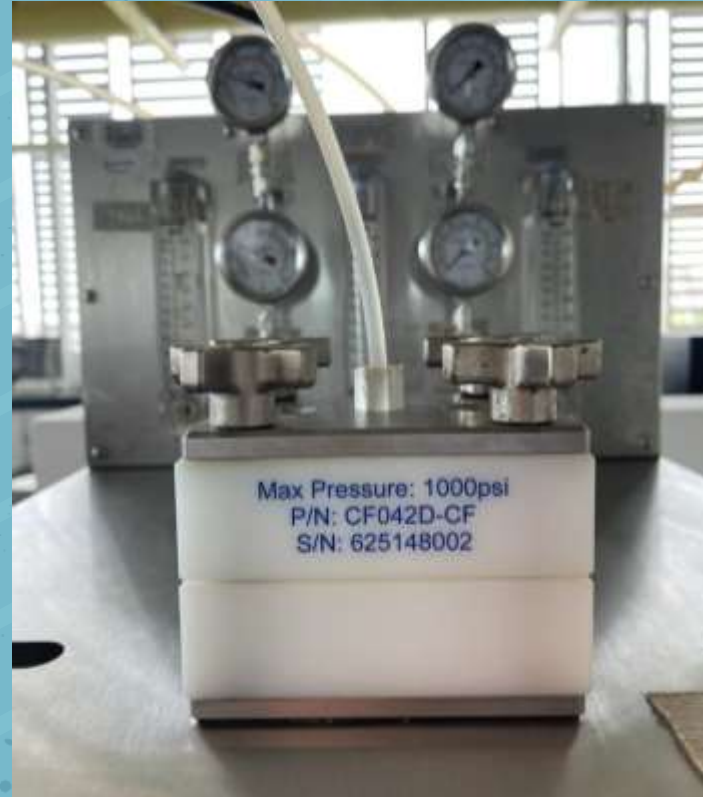

DESALINATION BY REVERSE OSMOSIS



- Potential solution to obtain drink water.
- Energy requirement: $11-15 \text{ kWh/m}^3$
- Brine disposal.
- Area: 42 cm^2 (Minimum scalable)

04

**SALINITY GRADIENT
ENERGY**

SALINITY GRADIENT ENERGY BY REVERSE ELECTRODIALYSIS



- CCD as DoE to evaluate RED process in each system proposed.
- The mixing of de $1 m^3$ of Seawater y $1 m^3$ of river water releases energy equivalent to a waterfall with a height of 200 m.
- Difference in chemical potential which could be transformed directly into electrical energy.

SALINITY GRADIENT ENERGY BY REVERSE ELECTRODIALYSIS

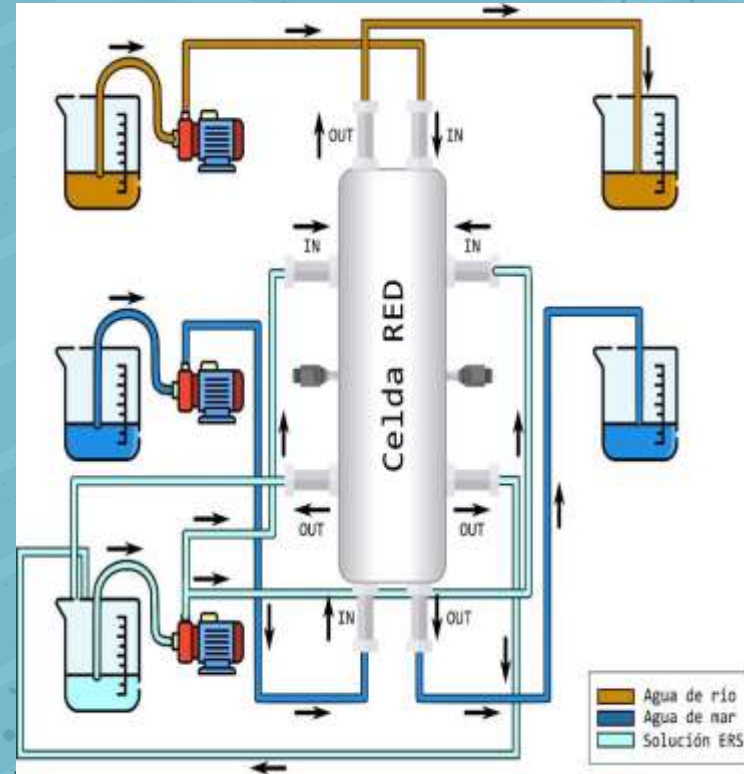

SALINITY GRADIENT ENERGY BY REVERSE ELECTRODIALYSIS

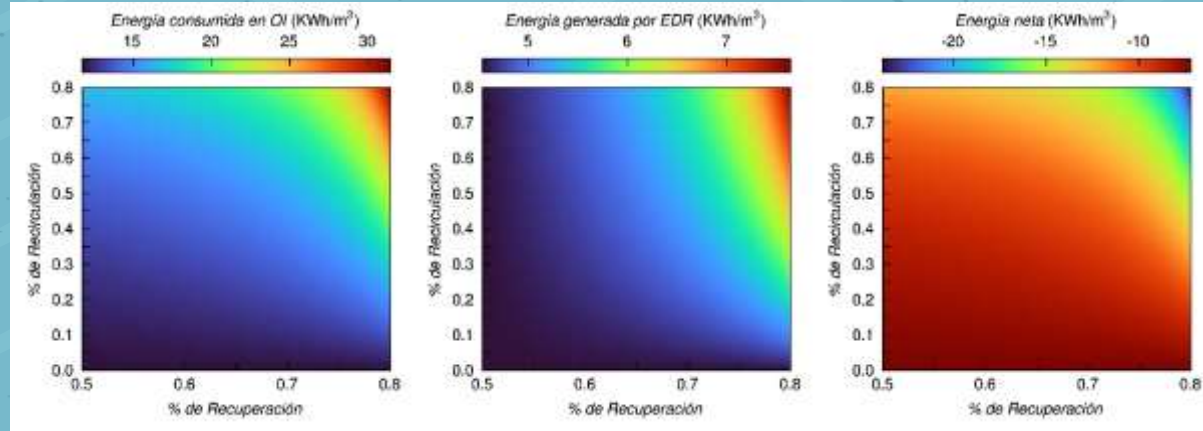
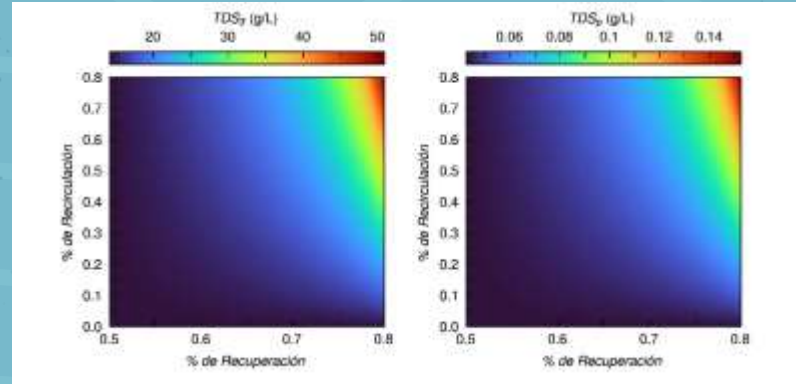

SALINITY GRADIENT ENERGY BY REVERSE ELECTRODIALYSIS

Pretreatment



Desalination



Salinity Gradient Energy (SGE)

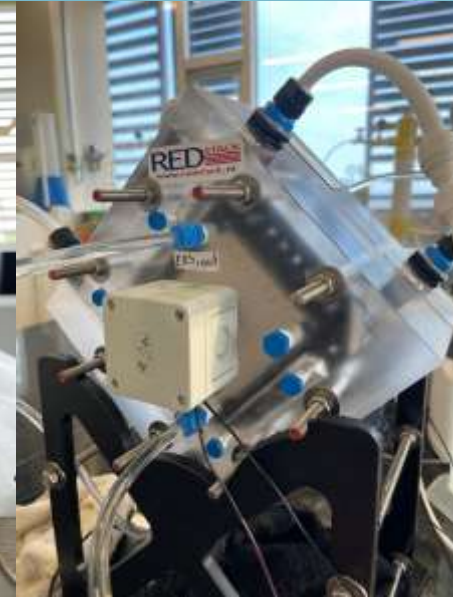

Power density:
Real Brine/River
water
 $0.34-4.35 \text{ W/m}^2$

05

CONCLUSIONS

Optimization of individual processes (RO and RED) might lead to the highest efficiency of the coupled system.

The location of a pilot plant should be where it can be easily found high and low-salinity waters.

Carrying out future work focused on the use of real water samples from our region leads to a better understanding of the phenomena and their actual potential applications.

Pretreatment is necessary for the samples of the Magdalena River and the Caribbean Sea.

Improving the water quality in the inlet of membrane systems is CRUCIAL to reduce costs and prevent early fouling.



THANKS!

Do you have any questions?

rojanos@uninorte.edu.co +57 314 584 4886

maturanaa@uninorte.edu.co

marchenar@uninorte.edu.co

This research was financed with resources from the 'AUTONOMOUS HERITAGE NATIONAL FINANCING FUND FOR SCIENCE, TECHNOLOGY AND INNOVATION FRANCISCO JOSE DE CALDAS' of the 'Ministry of Sciences, Technology and Innovation of Colombia (MINCIENCIAS)' developed under the financing agreement of contingent claim No. 80740-538-2020, within the framework of Minciencias Project 71743.